

FAN-CLUB

Download von:
www.ft-fanarchiv.de

Nr. 9
ZUM SAMMELN

**CLUBMODELL:
 „HARZER
 FAHRKUNST“**

Die Idee für das Modell stammt diesmal von FAN-CLUB-Mitglied Daniel Vollbrecht aus Neulußheim. Auf einer Urlaubsreise in den Harz hat er eine solche Anlage in einem Bergwerksmuseum gesehen. Es ist auf den ersten Blick schwer vorstellbar, aber mit einer solchen „Fahrkunst“ kann man mit einer immer gleichbleibenden Bewegung in einem Bergwerksschacht hinunter- oder hinauffahren. Immer wenn zwei Plattformen nebeneinander sind, muß man die Plattform wechseln. Probiert es aus, und Ihr werdet staunen! Wenn Euch ein paar Teile zum Nachbau fehlen, dann baut das Modell eben „so ähnlich“ oder bestellt fehlende Teile einfach bei unserem fischertechnik Einzelteil-Service (vorher bitte Bestellschein und Katalog anfordern)!

Tel. 0 74 43/12-43 69

Fax 0 74 43/12-45 91

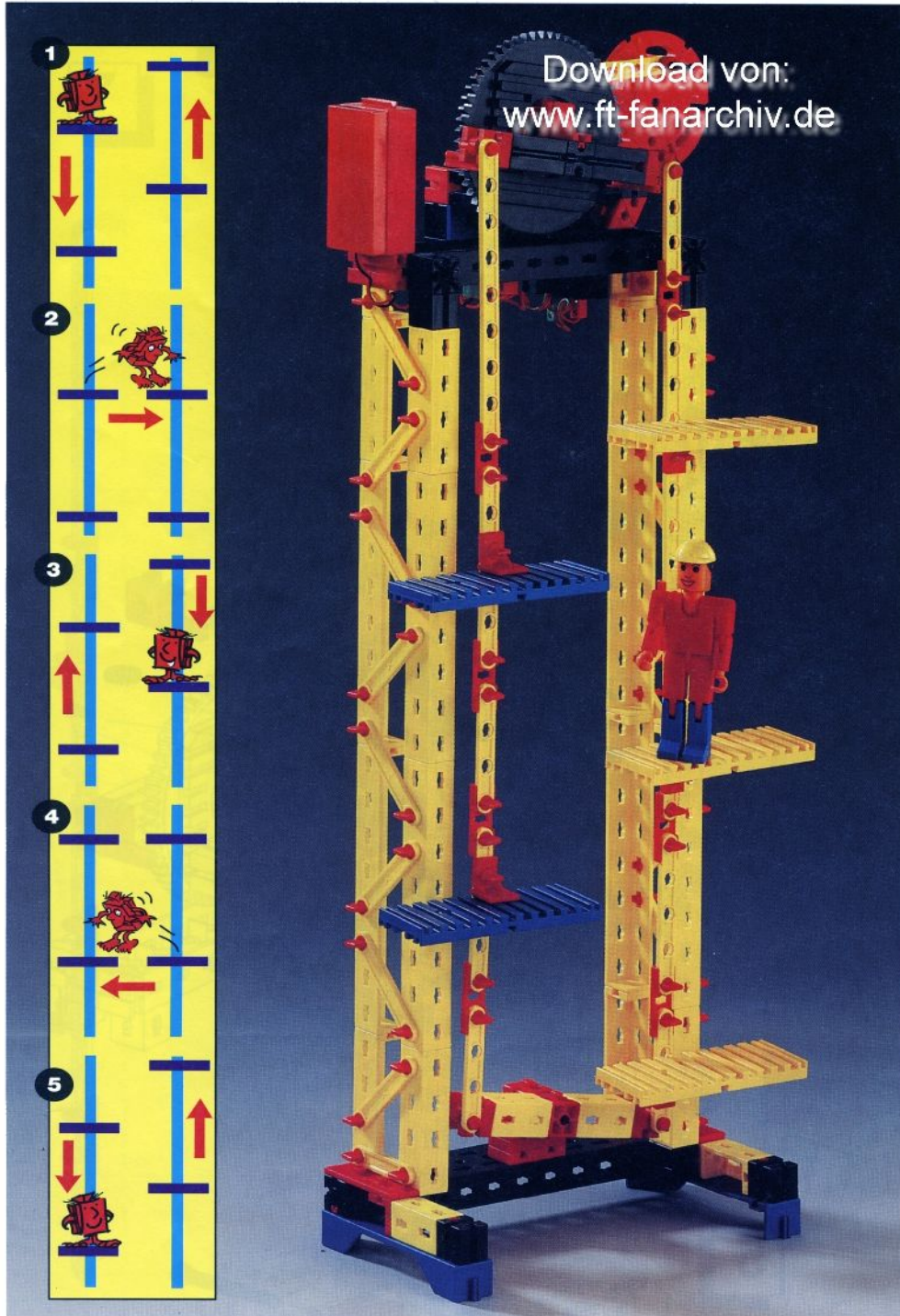

fischertechnik®



Harzer Fahrkunst

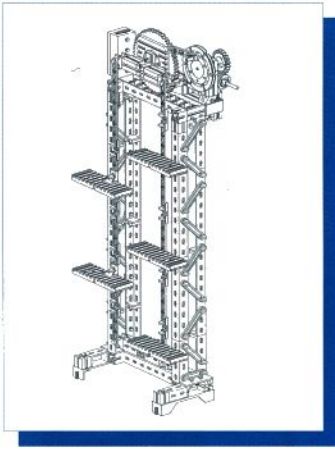

1

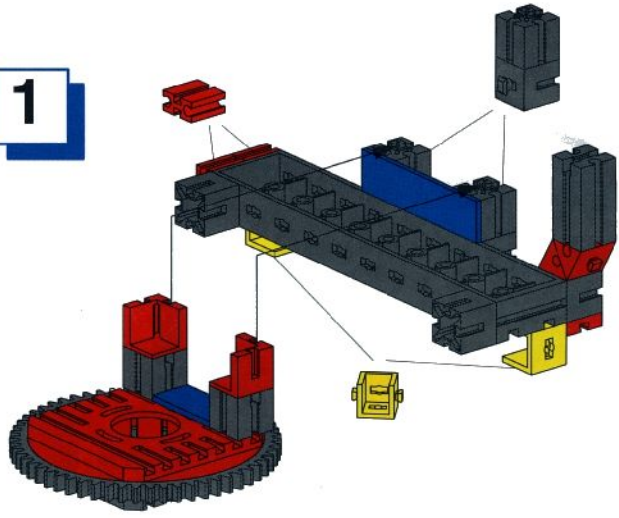

2

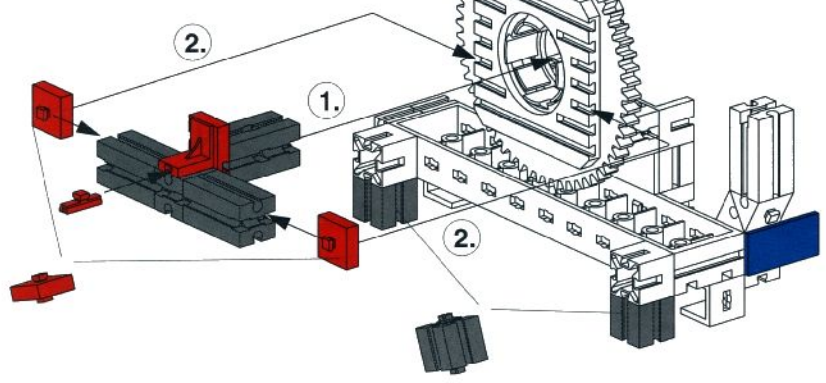

3

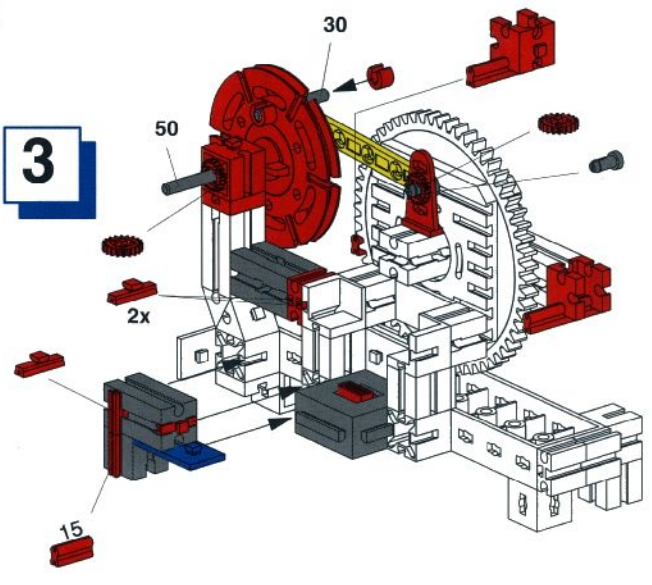

4

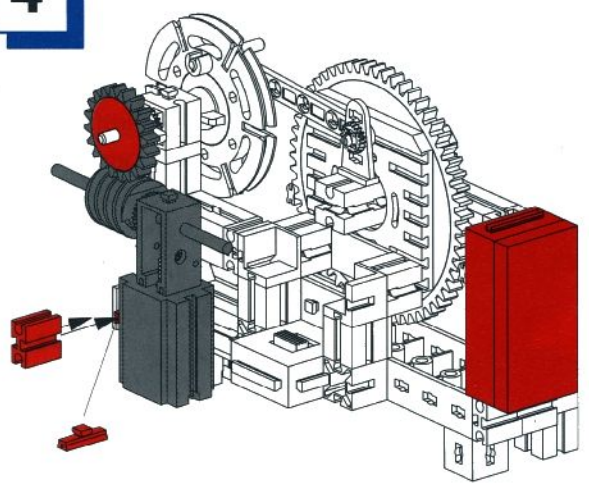

5

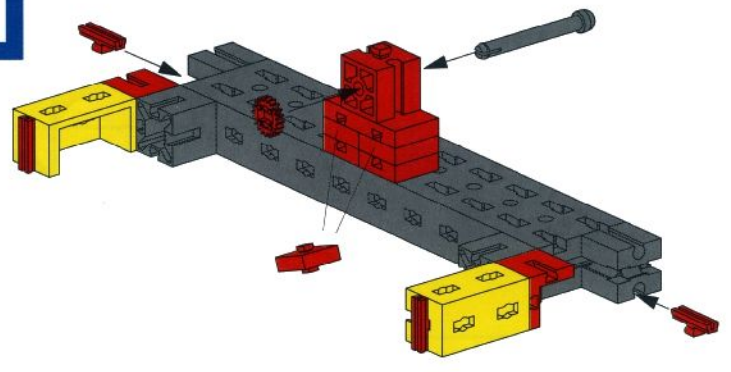

6

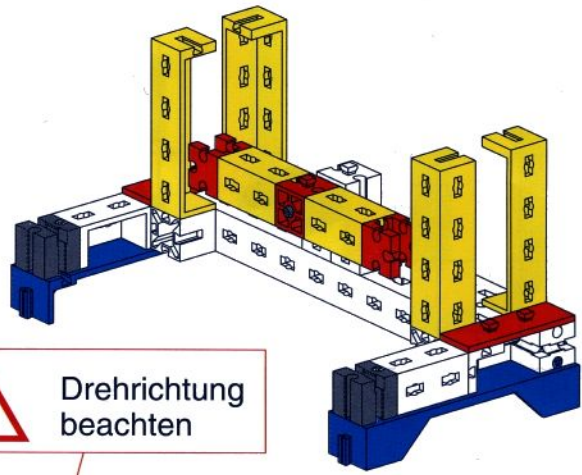





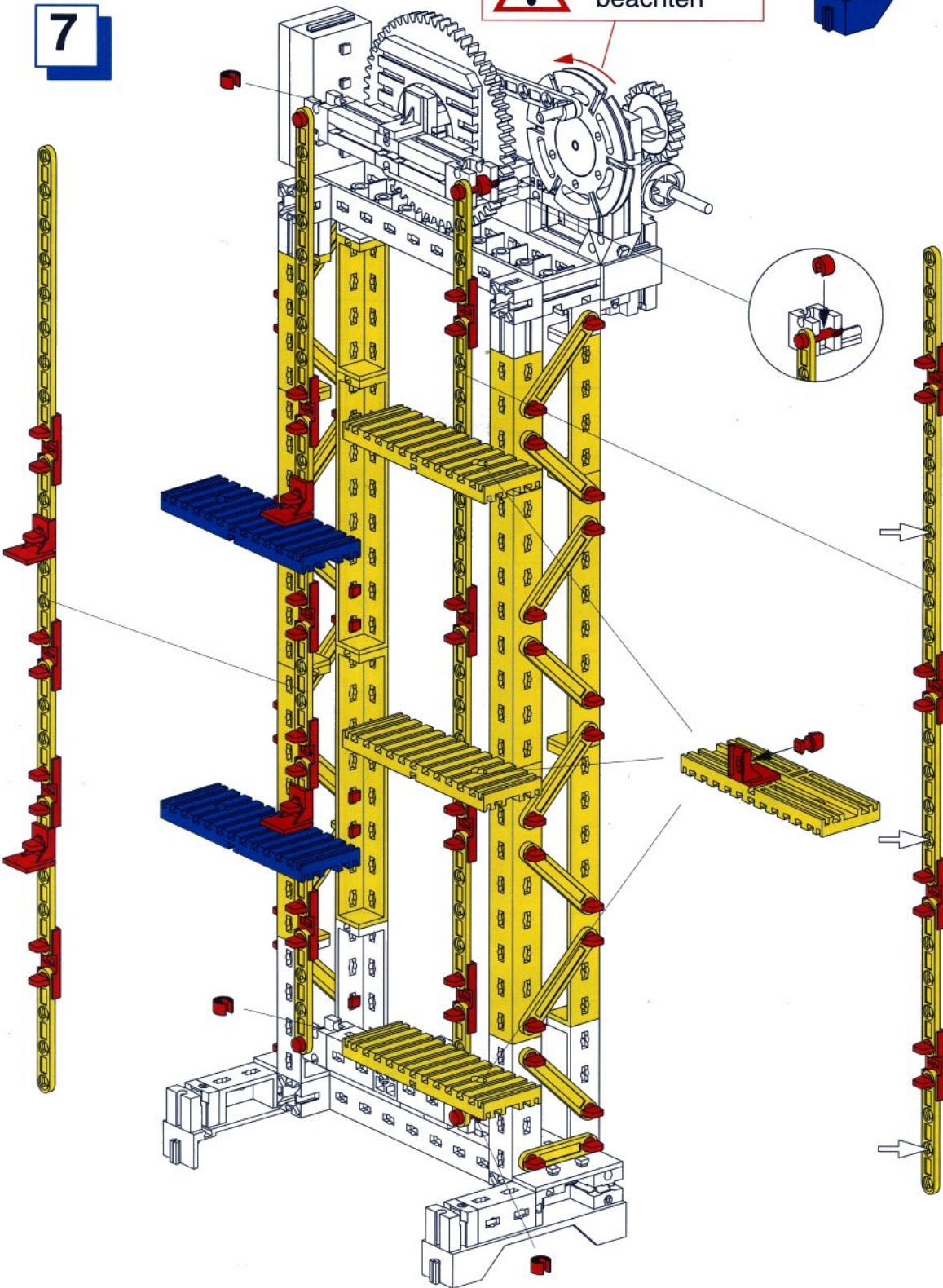















































 Drehrichtung beachten

7



Einzelteilübersicht

	Master/ Master Discovery	Master Plus Discovery Set	zusätzliche Teile		Master/ Master Discovery	Master Plus Discovery Set	zusätzliche Teile		Master/ Master Discovery	Master Plus Discovery Set	zusätzliche Teile
 60° 31010	2x			 32293	1x			 36026	1x		
 31019		1x		 32316		1x		 36294	8x		
 31021		1x		 32850	6x	1x		 36297	8x		
 31058	2x			 32854	2x			 36298	2x		
 15 31060		1x		 32860	2x			 36299	4x		
 30 31061	2x			 32861	3x			 36323	48x	9x	
 31078		1x		 32870	1x			 36334	3x		
 31390	1x			 32871	1x			 36382	1x		
 31391	1x				 36708			1x			
 31667	2x	6x		 32879	4x			 37237	4x		
 31674	4x	1x		 32880	2x			 37238	4x		
 31690	4x			 32881	8x			 37468	4x		
 30 31764	2x			 32882	4x			 37636	4x		
 31854	1x			 32886	1x			 37679	6x		
 31982	6x	4x		 32887	2x			 38240	4x		
 32064	3x			 32958	1x			 38260	1x		
 32233	1x			 35031	2x			 38267	3x		
 32263	1x			 120 35060		2x		 38277	2x		